

INSTRUCTIONS



WEATHER - BRAKE

2144

FITS

Kubota M4900, M5700, M6800, M8200,
M9000, M5700 SDN, & M8200 SDNB



General Offices
1132 W. 1ST STREET
McPherson, KS 67460
Phone: (620) 241-3513
Web: www.femcomfg.com

Form No. 286303600 / 09-2001

IMPORTANT

READ AND UNDERSTAND ALL INSTRUCTIONS BEFORE MOUNTING WEATHER BRAKE. DO NOT TIGHTEN HARDWARE UNTIL INSTRUCTED TO DO SO



LOADER

1. If loader is present on the tractor remove shield (A) on left side of loader. Shield on right side can be left on or taken off.
2. Bend joy stick rod towards steering wheel about 2". Location of bend is to be 12" from end of rod.

YOKE BRACKET

1. Remove two (2) bolts from top of dash.
2. Attach yoke bracket (A) to top of dash using the two (2) bolts removed
3. Tighten bolts.



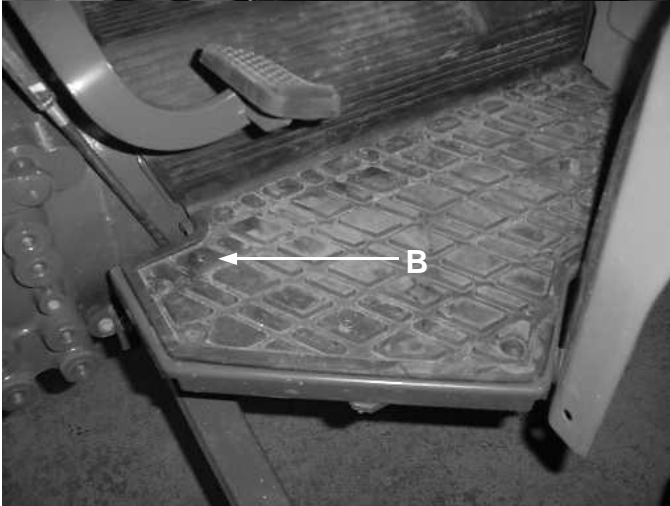
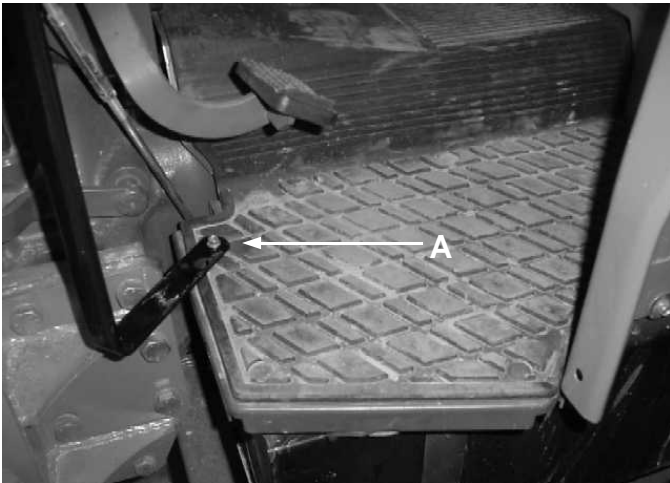

DOOR POST LOCATION

1. There are two (2) styles of foot rests. Style 1, remove plastic plug at location (A) and drill hole out to 9/32" diameter. Style 2, drill 9/32" diameter hole in middle of diamond at location (B).

DOOR POST ATTACHMENT

1. Style 1, attach door post (A) to top of footrest using one (1) 1/4" x 1" bolt and nut.
2. Style 2, lay six (6) 5/16" flat washers on top of diamond and attach door post (A) to footrest using (1) 1/4" x 1 1/2" bolt and nut.



MOTOR COVER

1. Arrange motor cover (A) over hood of tractor.
2. Slide 3" hem of motor cover down over door post.

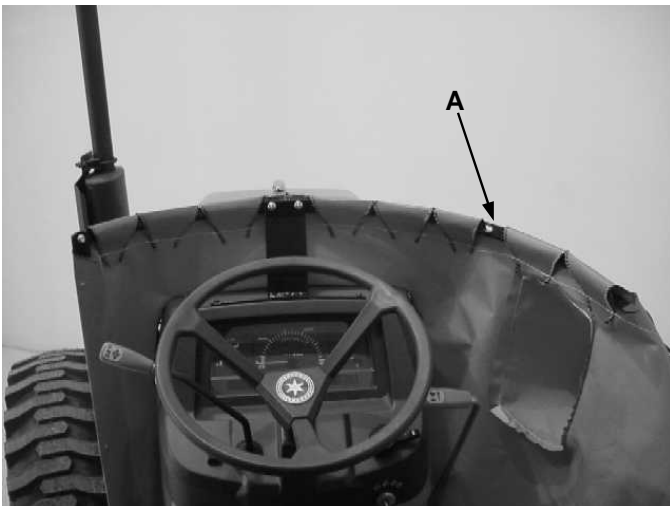
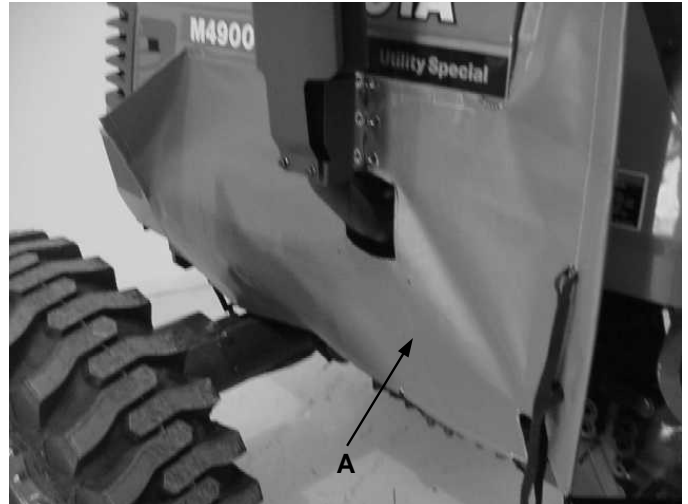

YOKE

1. Insert yoke (A) into top 3" hem of motor cover.
2. Attach yoke to yoke bracket using two (2) 1/4" x 3/4" bolts and nuts.
3. Attach end of yoke to door post using one (1) 1/4" x 1" bolt and nut. Bolt head inside, nut outside.
4. TIGHTEN ALL BOLTS.

SIDE ARM

1. There are 2 heights of fenders, high and low.
2. Side arm is to be level with yoke. Side arm with tall offset will be for low fender and side arm with short offset is for high fender.
3. Attach side arm (A) to yoke using one (1) 3/8" bolt and nut. Head of bolt down, nut on top.
4. Position hole in end of sidearm 3 1/2" from outside edge of fender and mark location of hole.
5. Drill a 9/32" diameter and attach sidearm to fender using one (1) 1/4" x 3/4" bolt and nut.
6. TIGHTEN ALL BOLTS.

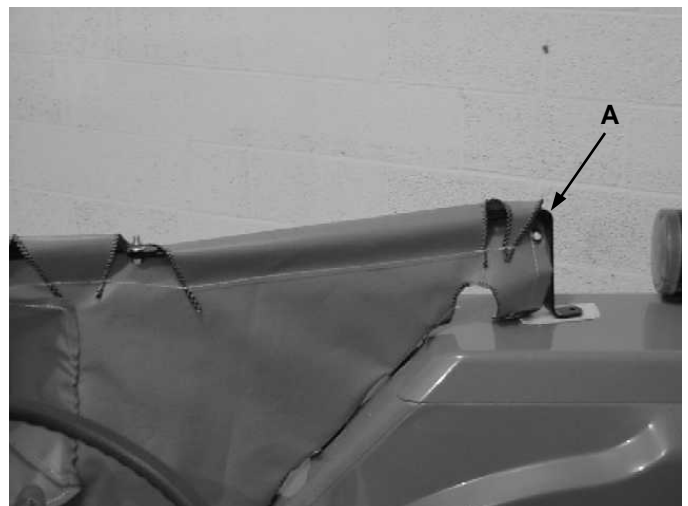



RIP OFF PATCHES & VELCRO

IMPORTANT: TO REMOVE RIP OFF PATCHES CUT EVERY FOURTH THREAD AND REMOVE

1. With tractors that have side exhaust, remove exhaust patch. On small tractors with short hood remove front extensions.
2. Count number of Velcro sewn to motor cover and cut that amount of plastic Velcro 4" long.

NOTE: DO NOT PEEL BACKING FROM VELCRO

3. Apply cut Velcro to all Velcro sewn to motor cover.
4. Arrange motor cover to tractor. Peel backing from Velcro and apply to tractor.

TIE STRAPS

Cloth straps are not to be attached to any moving, rotating, or heat generating points of tractor. Any excess cloth strap is to be cut off.

1. Thread cloth strap through grommets at bottom of motor cover and tie.
2. Attach all but three (3) "S" hooks to other side of motor.
3. Route cloth straps to other side or to a point on tractor and tie to "S" hooks or to a point on tractor.
4. If exhaust patch has been removed, attach "S" hooks to grommets on one side and pinch shut. Hook to other grommets.

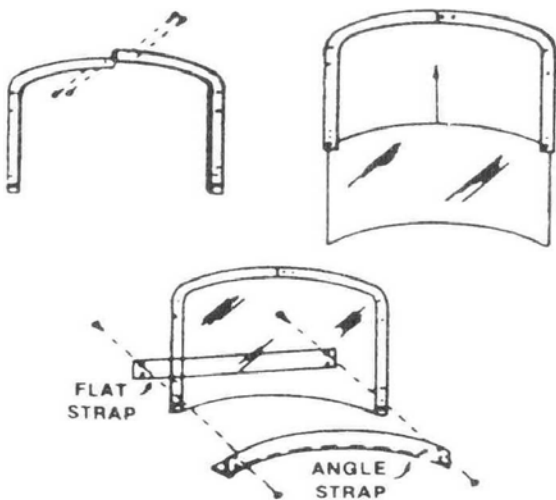

WINDSHIELD ASSEMBLY

1. Attach left and right window frames using two (2) #10 x 1/2" bolts and nuts.
2. Slide glass into the channel of the windshield.
3. Attach flat strip and angle strip to the windshield using two (2) #10 x 1/2" bolts and nuts.
4. TIGHTEN ALL BOLTS.

WINDSHIELD ATTACHMENT

1. Remove one (1) nut from yoke and top of door post.
2. Attach assembled windshield to outside of yoke using nut removed.
3. Attach other side of windshield to yoke using one 1/4" x 1" bolt and nut.
4. TIGHTEN ALL BOLTS

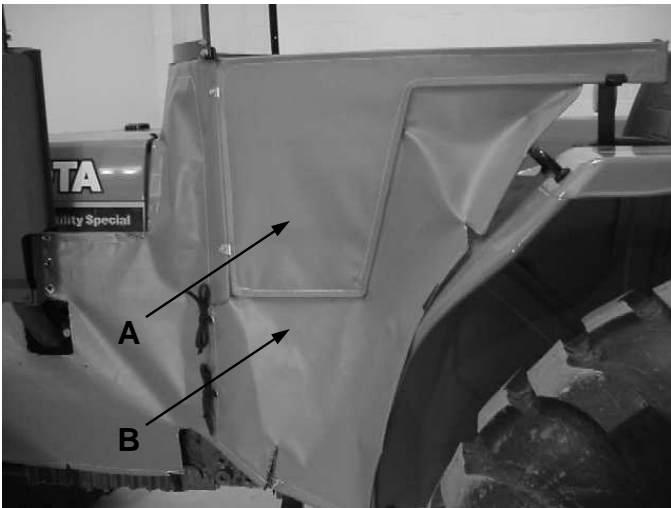

DOORS

1. Locate holes in door post and cut holes in fabric.
2. Hold door (A) to door post and bottom of windshield.
3. Mark location of holes in door post to door
4. Cut 5/8" slots next to wire frame of door and attach to door post using two (2) #10 x 3/4" bolts, clips, and nuts.
5. Tie door flap (B) to motor cover.
6. TIGHTEN ALL BOLTS.

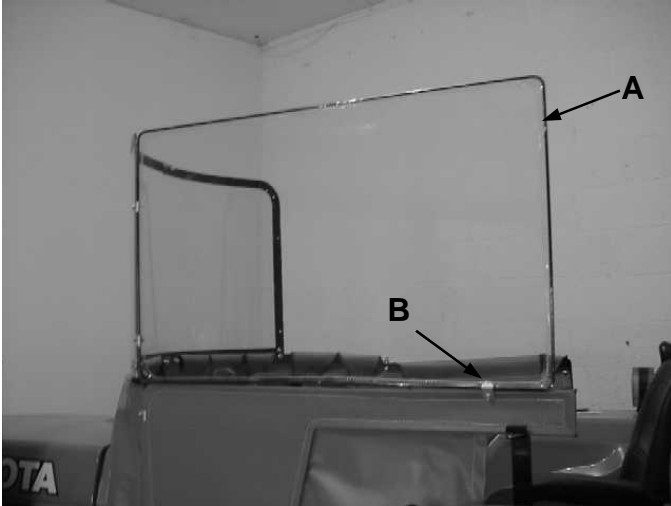
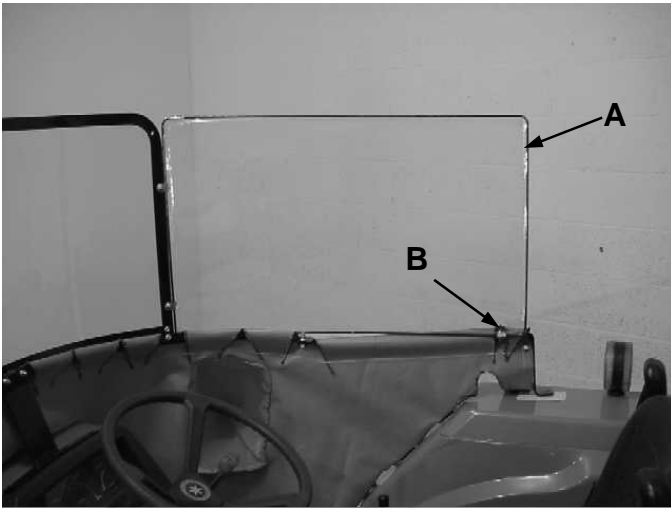

SIDE WINDOWS

1. Mark location of holes in windshield to side windows (A).
2. Cut 5/8" slots next to wire frame of windows and attach to windshield using four (4) #10 x 3/4" bolts, clips, and nuts.
3. At location (B), cut a 5/8" slot in bottom of side windows and attach to side arm and door using two (2) #10 x 3/4" bolts, clips, and nuts.
4. TIGHTEN ALL BOLTS.

LATCH

1. Position door wire in loop of latch (A) and mark location of bottom hole in latch.

Note: If second hole is in offset on fender, drill a hole between two holes through latch and fender.

2. Drill holes in fender using a 9/32" diameter bit.
3. Attach latch to fender using two (2) 1/4" x 3/4" bolts, flat washers and nuts.
4. CHECK AND TIGHTEN ALL HARDWARE.



NOTES